

A Rapid Procedure for the Determination of Chlorophyll in Rapeseed by Reflectance Spectroscopy

J.K. DAUN, Grain Research Laboratory, Canadian Grain Commission, 1404-303 Main Street, Winnipeg, Manitoba, Canada, R3C 3G9¹

ABSTRACT

In a new, rapid procedure, the chlorophyll content in rapeseed was estimated by reflectance spectroscopy. The seed was ground in a specially designed grinder. The reflectance of the ground seed was read at 630, 670, and 710 nm. Corrected absorbance at 670 nm was used to determine the chlorophyll content of the seed by using a calibration curve. The accuracy of the procedure was ± 1.2 ppm when compared to another published procedure.

INTRODUCTION

Rapeseed contains variable amounts of chlorophyll depending on its maturity. If this chlorophyll is extracted along with the oil, it will give a green color to the oil. An excessive amount of chlorophyll is considered detrimental as it is difficult to remove by routine processing techniques.

A method for determining the chlorophyll content of vegetable oils by measuring the intensity of its absorption at 670 nm has been adopted by AOCS as a standard procedure (1). Appelqvist and Johansson (2) have modified this procedure to allow rapid extraction of the chlorophyll and oil from the seeds, and the Swedish Oilseed Association has introduced a grading procedure based on this analysis (3).

Little is known about the chlorophyll content of Canadian rapeseed. In order to carry out surveys on the chlorophyll content of Canadian rapeseed involving several thousand analyses, a rapid procedure for chlorophyll determination was required. A procedure involving reflectance spectroscopic measurements on ground rapeseed was found to be very rapid and sufficiently accurate for examining large populations.

MATERIALS AND METHODS

Modified Absorbance Procedure

This procedure is basically as described in (2) but modified as below. Approximately 2.5 g of seed was dried for 16 hr (overnight) at 103 C. The seed was then weighed accurately and transferred to a 50-ml stainless steel centrifuge tube along with three stainless steel ball bearings (15 mm diameter). Heptane:ethanol (3:1) solution (30 ml) was then added. The tubes were then capped with Teflon lined stoppers [as described in (4)] and shaken longitudinally on an Eberbach Laboratory shaker (200 oscillations/min, 4 cm displacement) for a minimum of 45 min. The contents of the tubes were then filtered through Whatman #2^v filter paper, and the filtrate was collected in 25 x 150 mm culture tubes (with Teflon lined caps). The tubes were capped immediately to prevent evaporation. The absorption of the resulting solution was determined at 710, 667, and 630 nm. (Note: the absorbance maximum in heptane:ethanol solution was found at 667 nm on the Beckman Acta M VI used in this study). The chlorophyll content of the solution was then calculated by comparing with a calibration curve (Fig. 1) and the chlorophyll content of the seed was calculated as:

$$\text{chlorophyll in seed (ppm)} = \frac{30 \text{ ml} \times \text{chlorophyll in solution} (\mu\text{gm/ml})}{\text{wt seed (gm)}}$$

The standard curve was made using solutions of rapeseed oils containing various amounts of chlorophyll as determined by AOCS procedure Cc 13D-55 (1). The chlorophyll was added to the oils in the form of a diethyl ether extract of spinach leaves prior to determination of chlorophyll by the standard procedure. The oils were then dissolved in the heptane:ethanol solvent before determining the absorption of 710, 667, and 630 nm. The baseline corrected absorbance was calculated as:

$$A_{\text{CORR}} = A_{667} - (A_{630} + A_{710})/2.$$

"Reflectance" Procedure

Approximately 10 g of seed were ground in the GRL rapeseed grinder. This grinder (Fig. 2) consisted of a 6.25 HP motor turning a shaft at 17,500 rpm mounted on a modified drill press. The disposable plastic grinding cups (Fig. 3) were fitted with stainless steel blades which were attached to the grinder shaft with a drill chuck. The grinding operation consisted of transferring ca. 10 g of seed to the cup, attaching the lid with the blade, inserting the chuck, and grinding for a timed interval of 30 sec. The grind produced was finer than that obtained using a coffee mill.

The ground seed was transferred to the reflectance cell (Fig. 4). This cell was filled level with the top, and the back was inserted. This resulted in uniformly packed surface being presented to the beam of the spectrophotometer.

The cell was placed in the same beam of the spectrophotometer, a Beckman Color DB-G reflectance spectrophotometer, which had previously been adjusted to 100% reflectance using barium sulfate reflectance standards which were covered with plates of the same glass as used in the

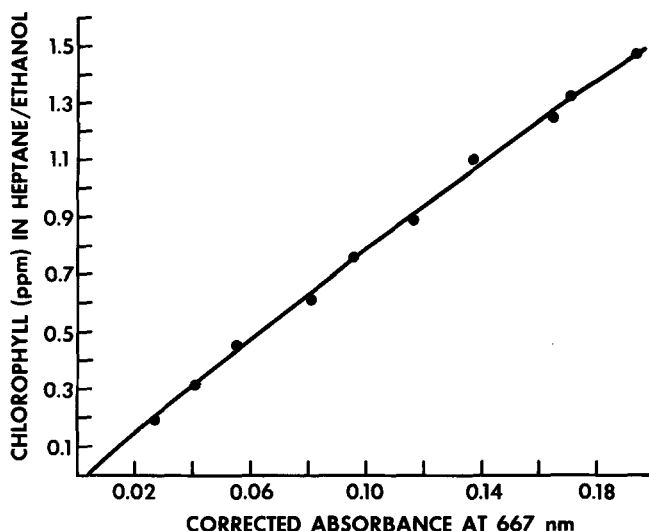

FIG. 1. Chlorophyll content of heptane:ethanol (3:1) solution of rapeseed oil (5%) plotted against corrected absorbance at 667 nm.

¹Contribution No. 362 from Grain Research Laboratory.

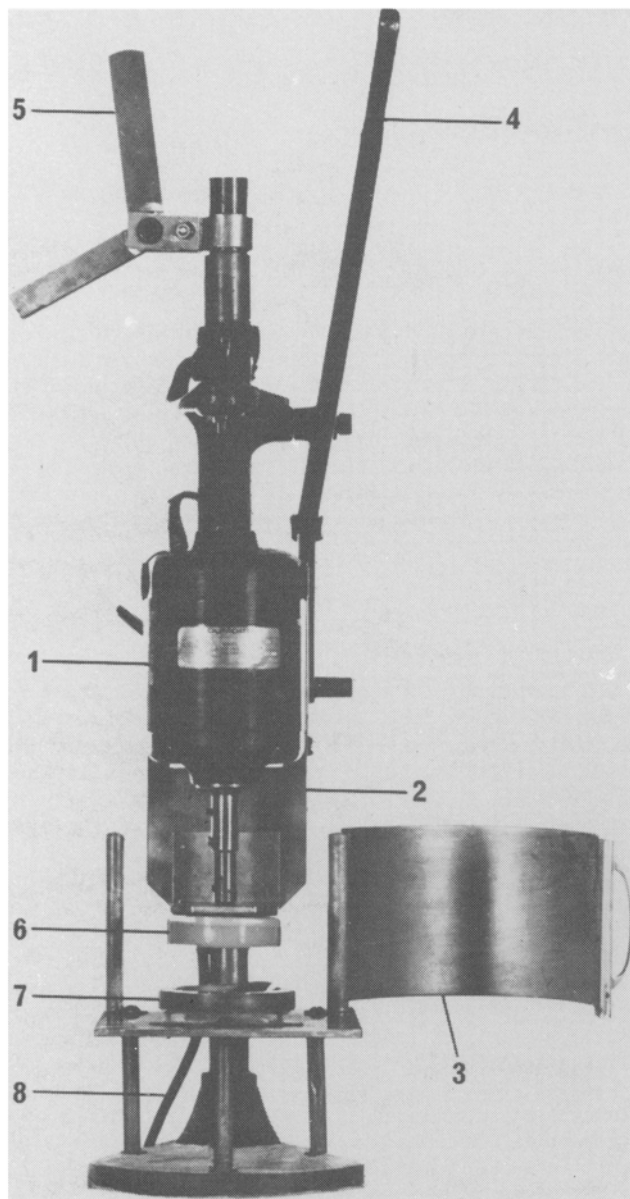

FIG. 2. GRL rapeseed grinder. (1) Motor, (2) Shaft and chuck, (3) Safety shield, (4) Handle for raising and lowering motor and shaft, (5) Guide for holding motor and shaft in grinding position, (6) Sample cup, (7) Rubber lined receptacle for sample cup, (8) Power cord leading to switch and timer.

sample cell. The reflectance at 710, 670, and 630 nm was read against the barium sulfate reference.

RESULTS AND DISCUSSION

The visible spectrum of crude rapeseed oils shows a sharp absorption band with a maximum at 670 nm (Fig. 5). This band is due to chlorophyll or related pigment in the oil. The reflectance spectrum of ground rapeseed also shows a band with maximum absorption (minimum reflectance) at 670 nm (Fig. 6). This band was used for our analyses.

The reflectance values were converted to absorbance values by the conversion $A = \log 1/R$. The baseline corrected absorbance at 670 nm for each sample was calculated ($A_{corr} = A_{670} - (A_{710} + A_{630})/2$).

A series of samples was analyzed by the absorbance procedure for chlorophyll content. The results from the absorbance procedure were plotted against the baseline corrected absorbance at 670 nm on the ground samples (Fig. 7). The best line drawn through these points was used

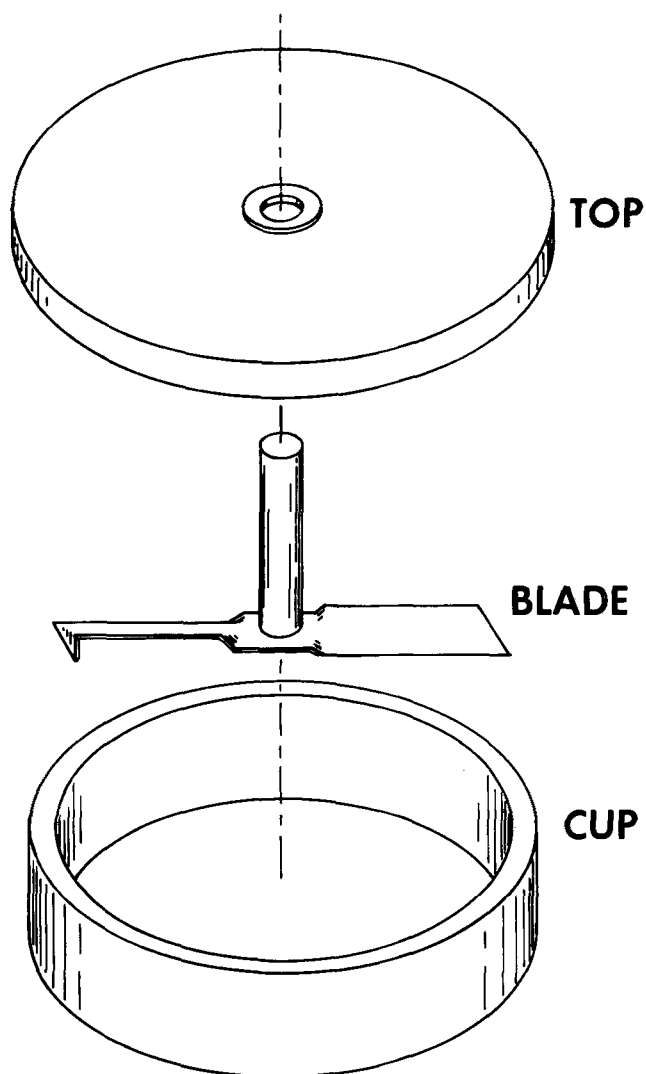

FIG. 3. Grinding Cup. Made from high density polyethylene. Cup dimensions are 9.5 cm OD x 2 cm high; wall thickness is 0.5 cm. The blade is stainless steel with sharpened edges with a blade angle of approximately 15°, blade length of 8 cm.

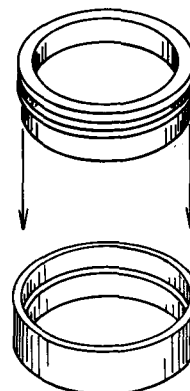
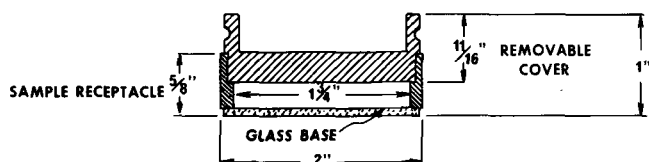

FIG. 4. Cell for reflectance spectrophotometer is manufactured from acrylic plastic. The glass cover is made from Kodak B351 slide cover glass.

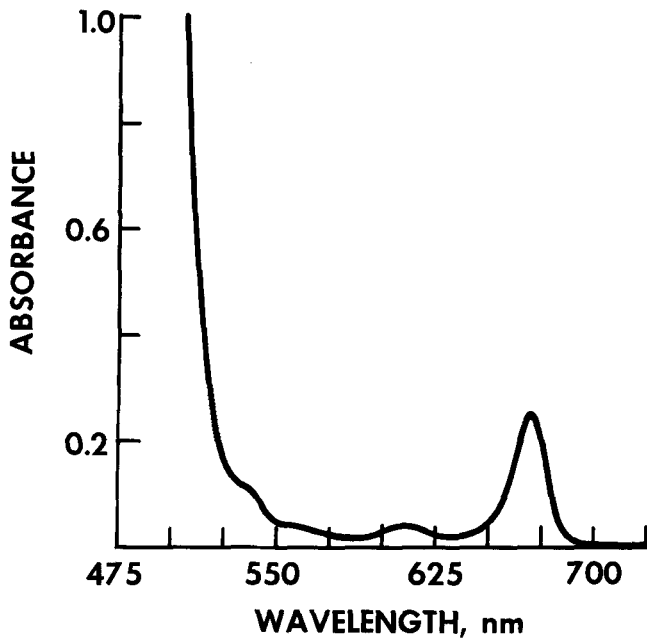

FIG. 5. Absorbance spectrum of rapeseed oil showing absorbance band at 670 nm due to chlorophyll.

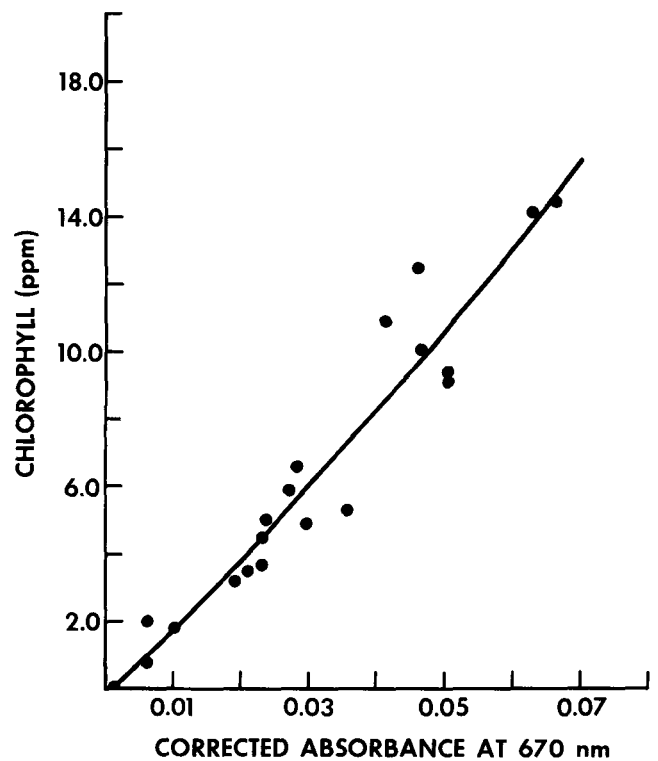

FIG. 7. Calibration curve for determination of chlorophyll in ground rapeseed using the reflectance procedure.

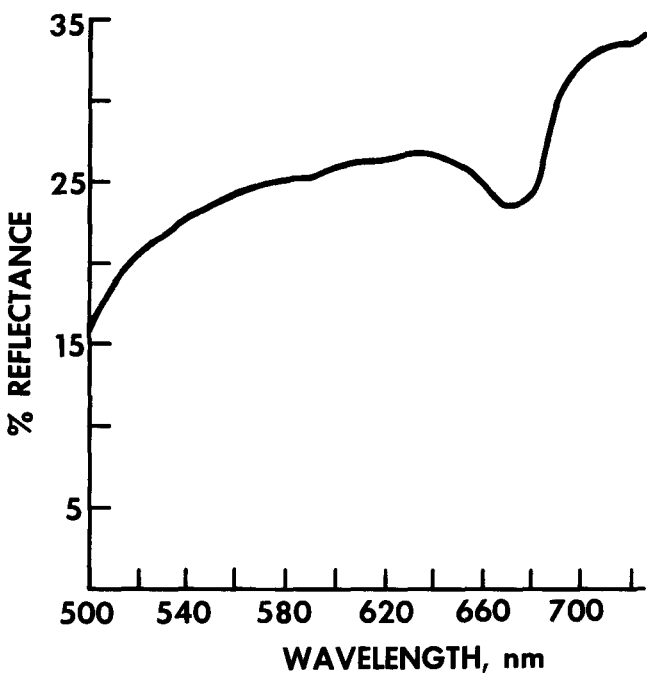

FIG. 6. Reflectance spectrum of ground rapeseed showing absorbance at 670 nm.

as a calibration curve for the reflectance procedure.

The precision and accuracy of the procedure was estimated in two experiments. In the first experiment, replication on a single sample was tested. Ten samples from the same lot of seed were analyzed by both the absorbance and the reflectance procedure. The results—absorbance procedure 7.3 ± 0.3 ppm [± 1 standard deviation (SD)]; reflectance procedure 5.7 ± 0.7 ppm (± 1 SD)—indicated the precision of the individual methods. If the mean for the absorbance procedure is taken as the accurate or reference measurement, the root-mean-square (RMS) deviation of the reflectance procedure becomes ± 0.9 ppm. This larger value takes into account differences in the means as determined by the two procedures and thus is a measure of the

TABLE I

Chlorophyll Content of Nine Samples of Rapeseed as Determined by the Absorbance and Reflectance Procedures

Absorbance procedure ^a	Reflectance procedure ^b	
	A	B
4.1	3.2 (-0.9)	3.3 (-0.8)
5.5	5.0 (-0.5)	5.7 (0.2)
8.4	7.6 (-0.8)	8.6 (0.2)
8.2	7.5 (-0.7)	9.3 (1.1)
8.8	9.5 (0.7)	8.9 (0.1)
9.3	7.6 (-1.7)	11.9 (2.7)
10.1	8.1 (-2.0)	10.2 (0.1)
11.8	11.2 (-0.6)	11.6 (-0.2)
12.2	10.9 (-1.3)	13.9 (1.7)

^aMean of five individual determinations.

^bIndividual determinations. Number in brackets indicates the deviation from the average of five absorbance procedure determinations.

accuracy of the reflectance procedure.

In the second experiment, a series of nine samples ranging in chlorophyll content from 4-12 ppm were each analyzed five times by the absorbance procedure and twice by the reflectance procedure. The results for the absorbance procedure were averaged for each sample and these averages were taken as accurate values for consideration of the accuracy of the reflectance procedure. Each reflectance measurement was considered separately. The results (Table I) indicate that the RMS difference between the absorbance and reflectance results is ± 1.2 ppm. This indicates a measure of the accuracy of the reflectance procedure taking into account differences between samples.

This degree of accuracy and precision is suitable for carrying out surveys on large numbers of samples or for rapid screening work. The reflectance procedure is very rapid since the samples have only to be ground before measuring the reflectance. No drying or weighing is required. An experienced operator can analyse 60-80

samples in an eight hour shift. For experiments where the number of samples is small and a higher degree of accuracy is desired, the more laborious absorbance procedure is preferred.

ACKNOWLEDGMENTS

GRL grinder was designed by G. LeSeelleur. Spectrophotometric analyses were done by Y. Lewanski, M.J. Blank, L. Davidson and T. Krocak.

REFERENCES

1. "Official and Tentative Methods of the American Oil Chemists' Society," Vol. I and II, Fourth Edition, AOCS, Champaign, IL, 1971 (revised to 1974), Method Cc 13d-55.
2. Appelqvist, L.Å., and S.Å. Johansson, J. Swed. Seed Assoc. 77:415 (1967).
3. Dahlen, J.Å.H., JAOCS 50:312A (1973).
4. Levi, I., P.B. Mazur, and T.W. Nowicki, J. Ass. Offic. Anal. Chem. 55: (1972).

[Received June 28, 1976]